

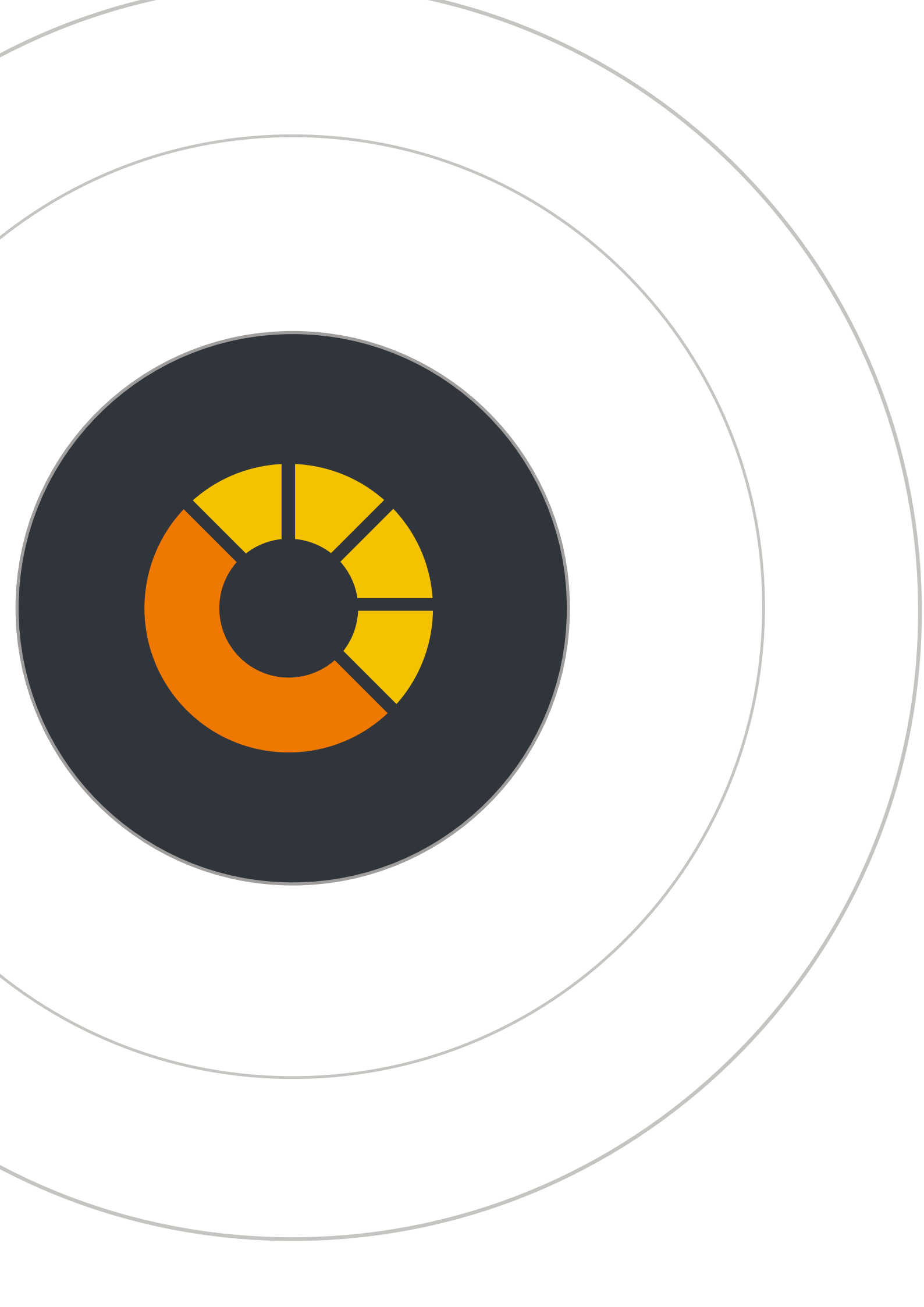

**HOPERGY**  
**PRODUCT CATALOG**  

---

**ENG ver: 1.0**



## PAGE OF CONTENT

01	<b>ABOUT US</b>	04
02	<b>WORLDWIDE</b>	05
03	<b>TIN</b>	06
04	<b>TIN INTERFACE</b>	08
05	<b>TILE</b>	10
06	<b>TILT</b>	13
07	<b>POLE</b>	16
08	<b>GROUND</b>	18
09	<b>CARPORT</b>	22
10	<b>RAIL</b>	24
11	<b>RAIL FIXING</b>	25
12	<b>MODULE CLAMP</b>	26
13	<b>GROUND SCREW</b>	28
14	<b>ACCESSIORES</b>	29

“

Our products can be extended indefinitely, minimising wastage, cost and improving overall efficiency.

”





Hopergy International presence is rapidly increasing by setting up branches and offices across the globe to make our products and services more accessible to local customers.

Hopergy is also partnering with a selected number of competent distributors and system integrators worldwide to explore and support the solar industry and most importantly to do our part in making this world a cleaner and safer place for future generations.





Hopergy's Tin (Metal) Roof Mounting Solution is suitable for almost any flat roof. It provides a simple and cost-effective solution for mounting all framed and unframed solar panels currently on the market. Hopergy's wide range of mounting brackets provide for fast and secure fixing to sheet metal, purlins or rafters and for different roofing types at angles from 10 to 60° . To simplify connection of support rails to brackets, Hopergy's rails are designed to allow fixing nuts to be simply swivelled into the rails.

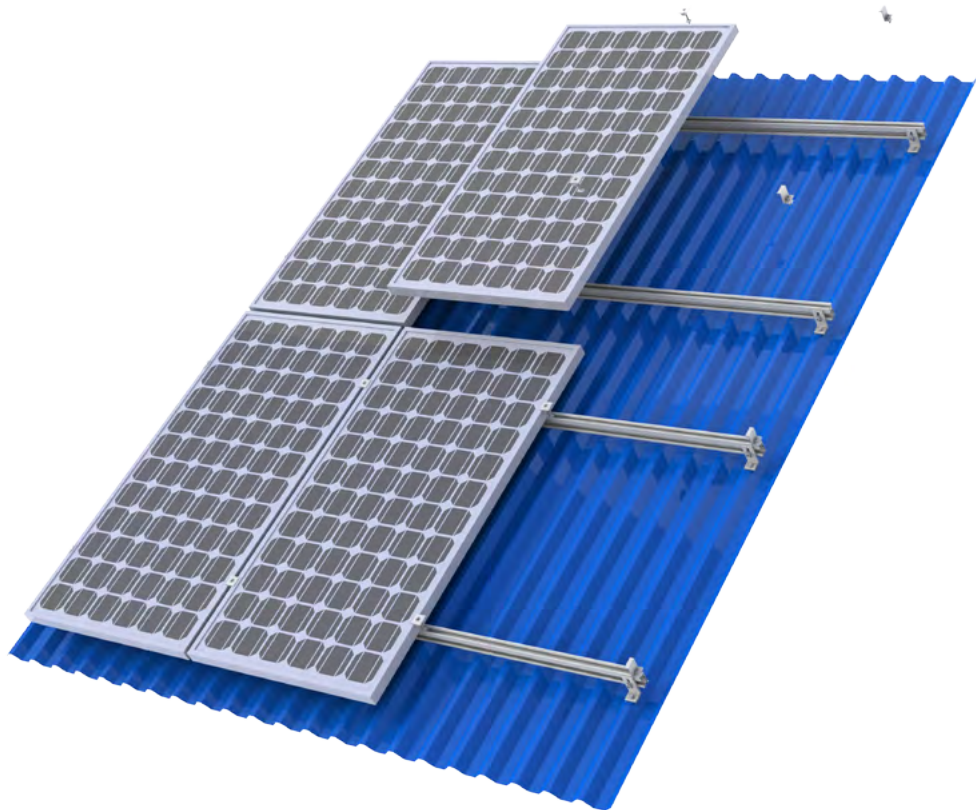



HOP-TRB-01



HOP-TRB-02



HOP-TRB-03



HOP-TRB-04



HOP-TRB-05



HOP-TRB-06





For convenience of installation, Hopergy has developed innovative solutions that provide strong and stable mounting for the following proprietary tin roof profiles. These systems can be used with or without rails.

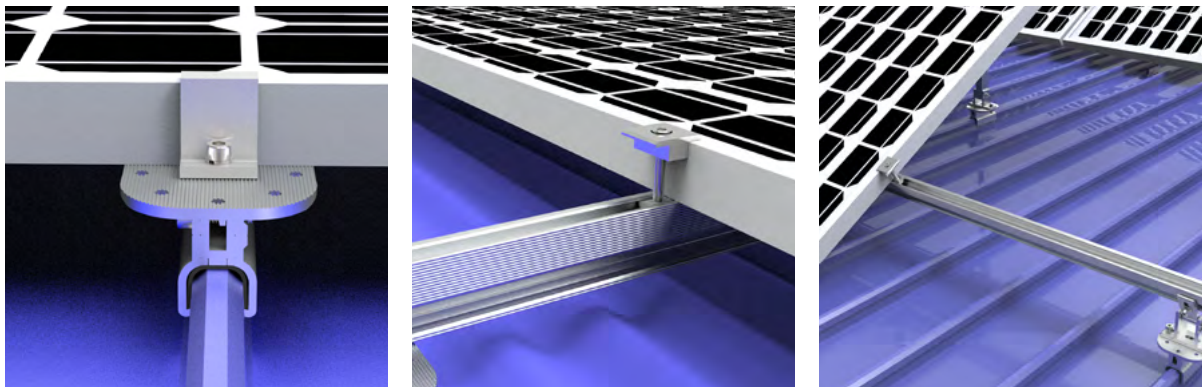

## HOP-KLK\*



\*various versions available

## Kliplok Interface

Hopergy's HOP-KLK is a mounting solution for Lysaght Klip-Lok and Stramit Speed Deck Ultra roofs, providing a solid mount that doesn't penetrate the roof surface. A highly durable EPDM rubber cushion in the clamp prevents corrosion at the roof interface. The solution is compatible with the HOP Tilt-Leg system, allowing quick and easy tilting from 10 to 60 degrees.

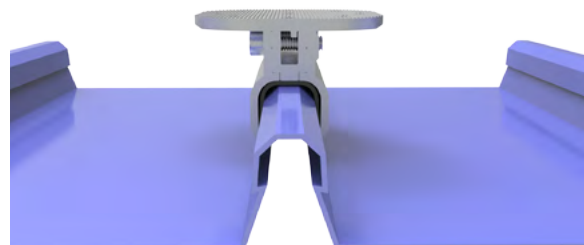
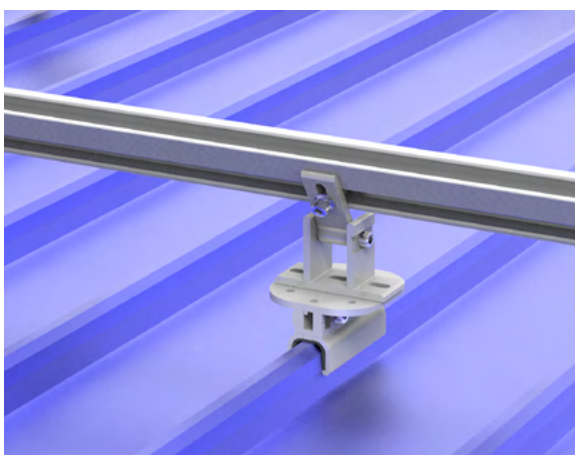





## HOP-TRK



## Lysaght Trimdek Interface

Hopergy's HOP-TRK is a mounting solution for Lysaght Trimdek roofs. The system doesn't use rails. Panels are fixed directly to mounting brackets fixed into purlins or rafters. The solution is compatible with the HOP Tilt-Leg system, allowing quick and easy tilting from 10 to 60 degrees.

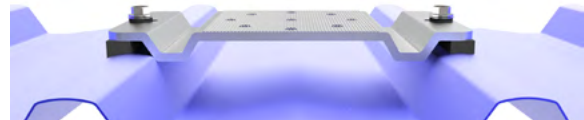
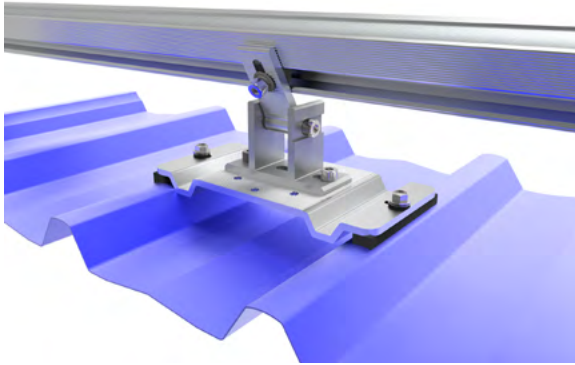

## HOP-COB



## Lysaght Custom Orb Interface

Hopergy's HOP-COB is a mounting solution for Lysaght Custom Orb roofs. The system can be used with or without rails. Panels are fixed directly to mounting brackets fixed into purlins or rafters. The solution is compatible with the HOP Tilt-Leg system, allowing quick and easy tilting from 10 to 60 degrees.

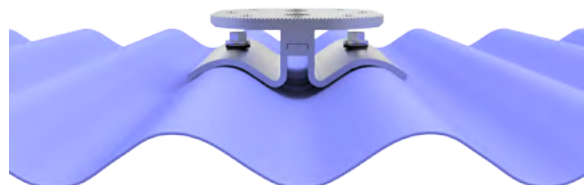
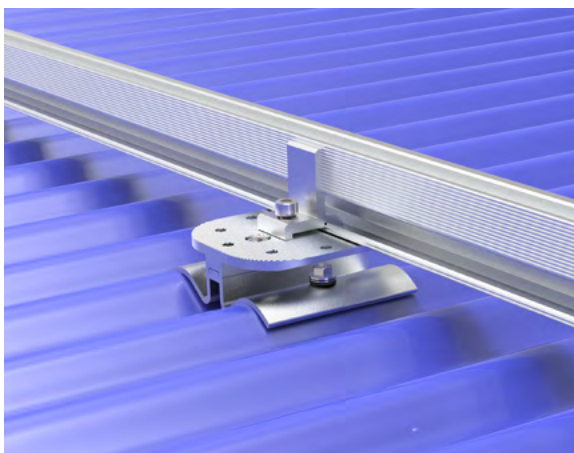



Hopergy's Universal Tiled Roof Mount is suitable for almost any flat roof. It accommodates all framed and unframed solar panels currently on the market. Hopergy's complete product range of mounting brackets provide for fast and simple fixing to purlins or rafters, without affecting the integrity or function of the tiles themselves. Roof brackets are available for traditional profile tiles and flat tiles.

To simplify connection of support rails to the brackets, Hopergy's rails are designed to allow fixing nuts to be simply swivelled into the rails.

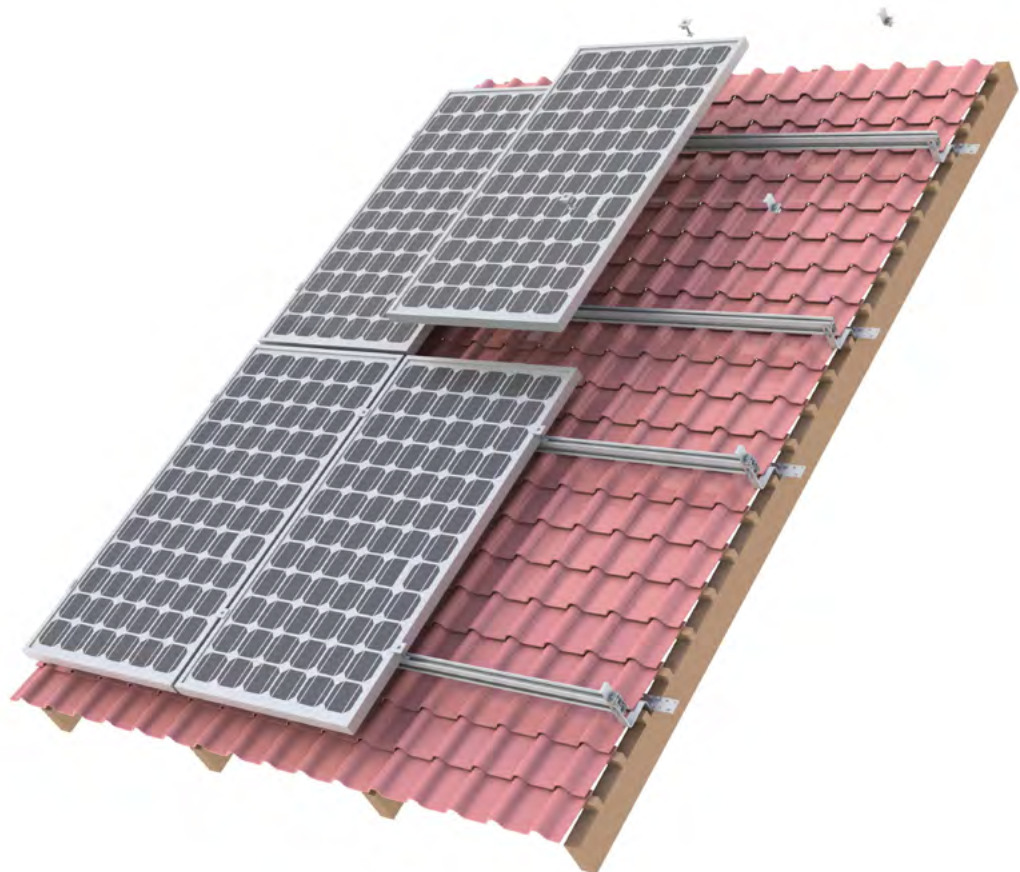



# Clay Tile Interface

HOP-TRH-01



HOP-TRH-02



HOP-TRH-03



HOP-TRH-04



HOP-TRH-05





## Flat Tile Interface

HOP-TRH-06



HOP-TRH-07



HOP-TRH-08



## Slate Tile Interface

HOP-TRH-09



HOP-TRH-10





Hopergy's Tilt Systems are quick and easy to install, allowing solar panels to be installed in the angle ranges from 10 to 15 degrees, 15 to 30 degrees and 30 to 60 degrees.

To simplify installation, components are pre-assembled before delivery to site.

- Available tilt angles 10–15°, 15–30° and 30–60°
- Easy to fold, save storage and transportation
- Simple and fast installation
- Easy access to components and connections

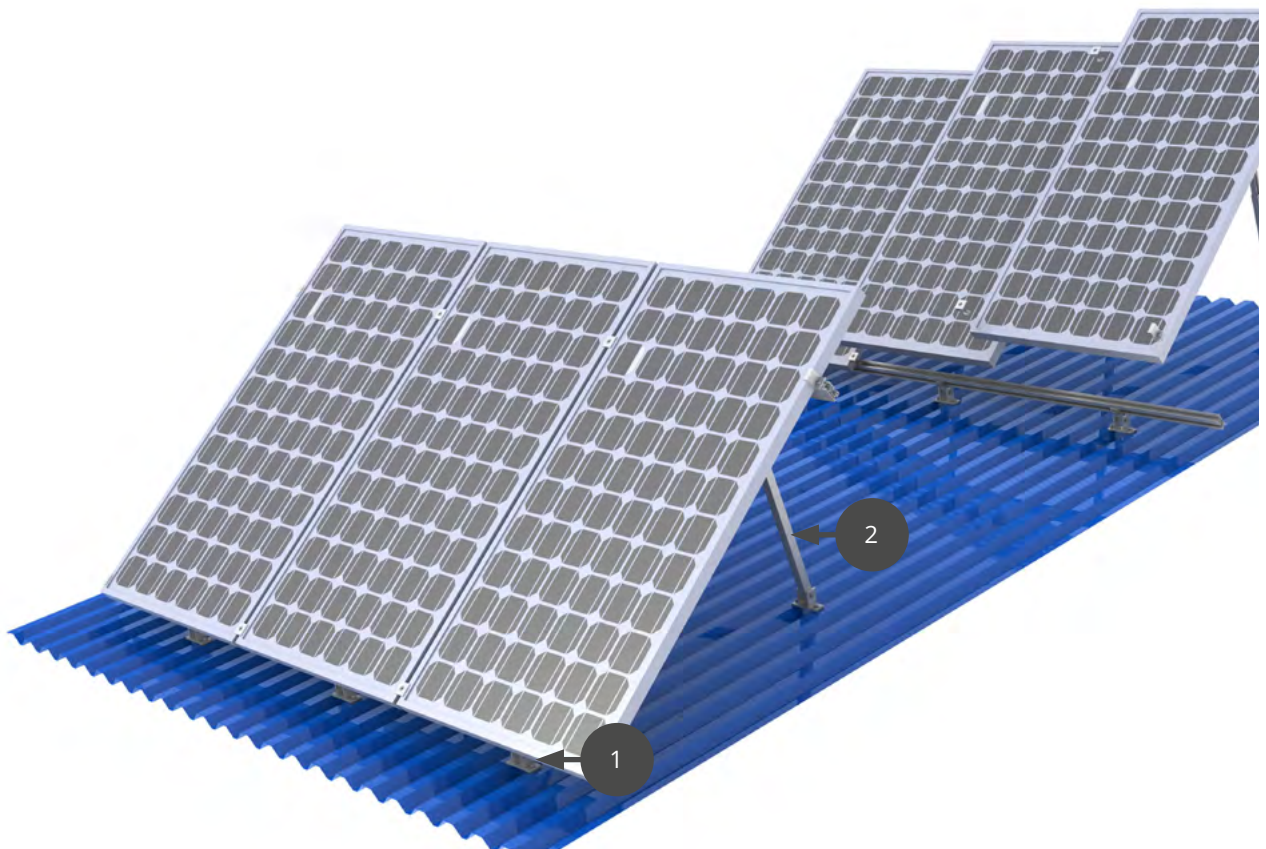

1 HOP-AFL



**Adjustable Front Leg**  
Hopergy's TILT-LEG System is truly innovative. Length adjustment on front and rear legs makes the system extremely versatile.

2 HOP-ARL\*



\*various versions available

**Adjustable Rear Leg**  
Hopergy's TILT-LEG System allows solar panels to be installed safely and quickly adjusted within the angle ranges 10 to 15 degrees, 15 to 30 degrees and 30 to 60 degrees from the mounting surface.

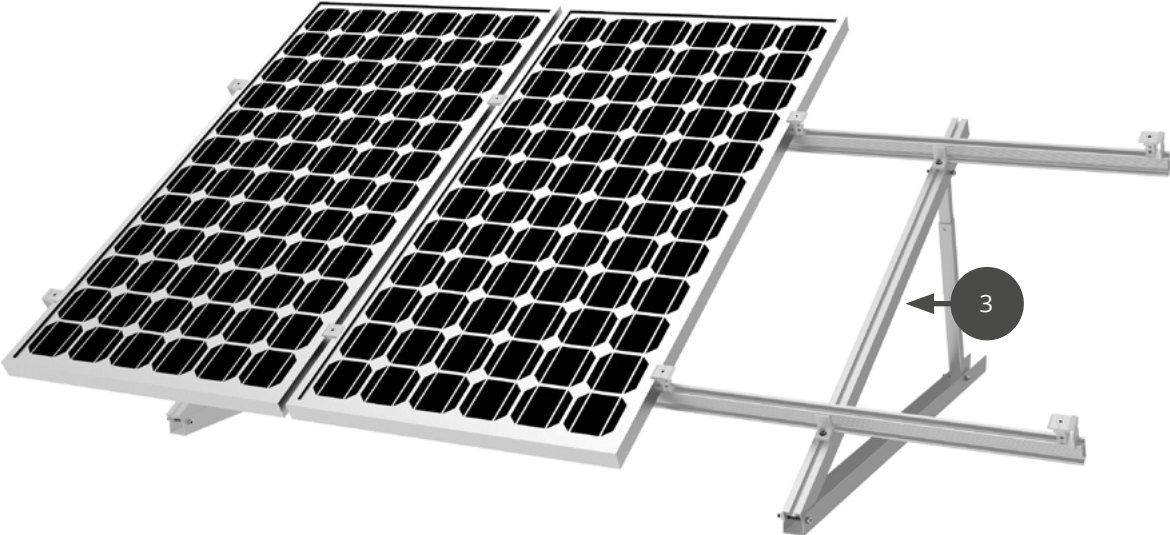

**3 HOP-AFK\***

\*various versions available

**A-Frame Kit**

Hopergy's A-FRAME KIT is the perfect solution when structural stability is critical in the harshest environments, whether on flat roofs or on the ground. The system is extremely strong and durable, but is quick and easy to install. It allows solar panels to be installed safely and quickly adjusted within the angle ranges 10 to 15 degrees, 15 to 30 degrees and 30 to 60 degrees.



Pre-Assemble



Click in Rail design



Hopergy's Pole Mount System is the perfect solution when maximum flexibility is required in the installation.

Any number of poles can be installed to grow the system. Poles can be rotated to the optimum orientation, and the array of panels on each pole can be turned to any one of five angles: 10, 20, 30, 40 or 50 degrees to maximise power generation.

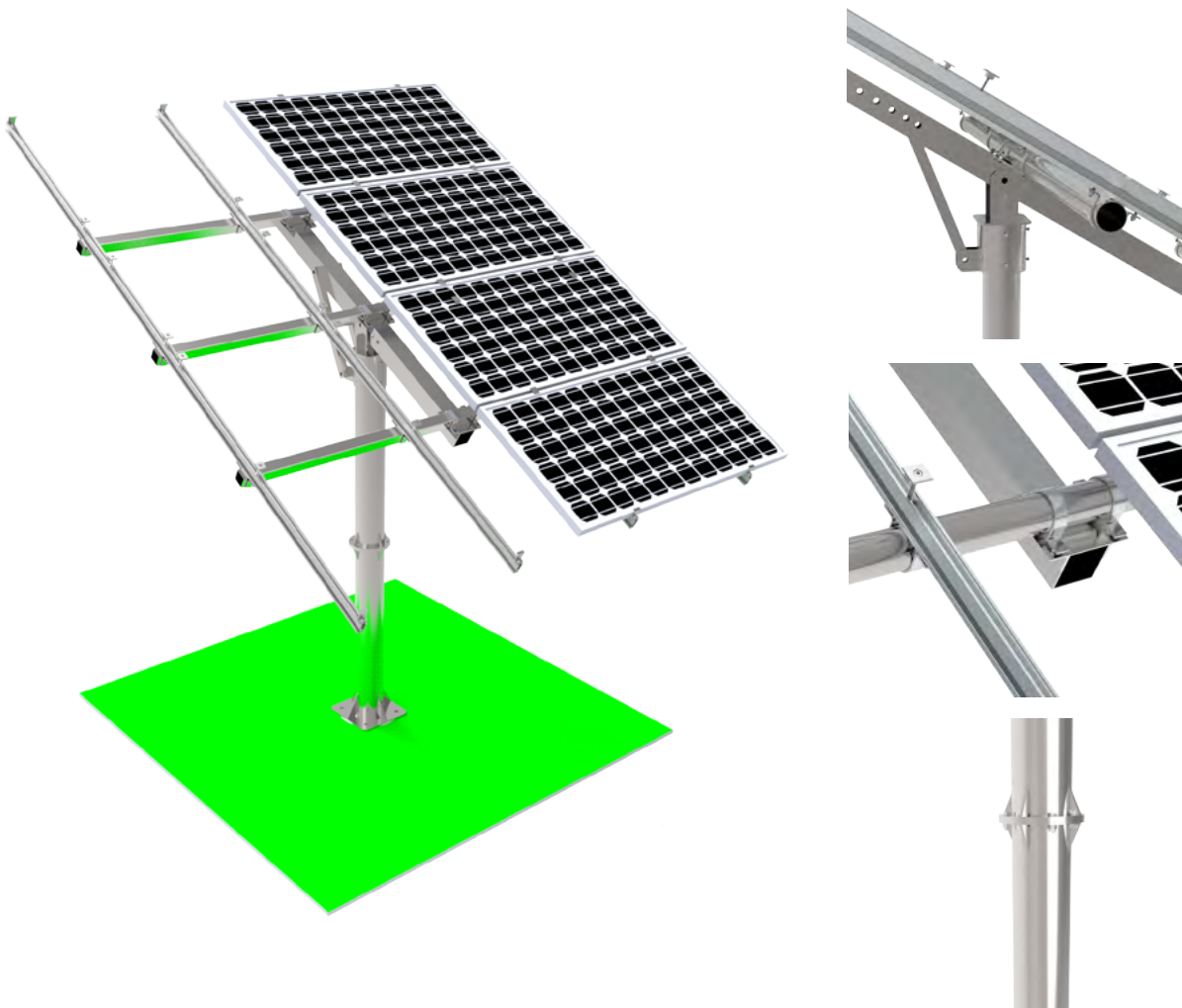





PM4



PM6



PM8

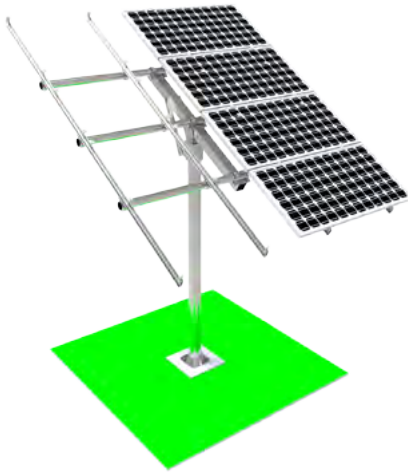

PM10





Hopergy's Ground Mount System is designed for medium to large scale project installation. The most appropriate ground mount for any outdoor site depends on project size, engineering considerations, mounting surface material, soil conditions and ground topography, so Hopergy offers a diverse range of ground mounting systems to ensure a solution is available for every application, location and environment. Each system is designed for simple installation, durability, cost-effectiveness and flexibility in design and installation.





## Quick Assembly

Numerous pre-assembled parts including the universal height-adjustable module clamps reduce assembly times



## Foundation Optimization

Engineered flexibility greatly reduces grading requirements. Alternate foundation options include welded plate, concrete pour, ballast, and ground screw.

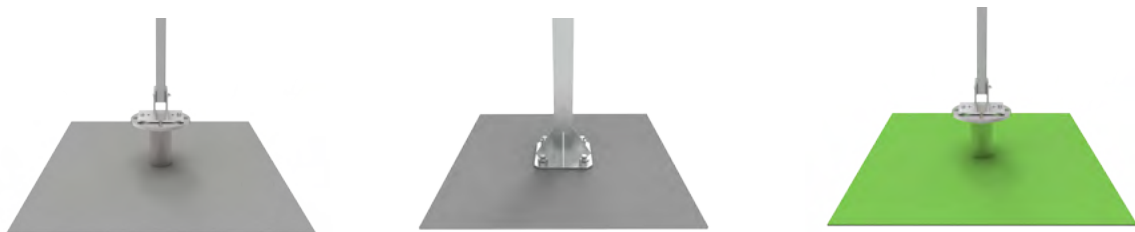



## Ultimate Flexibility

System allows for easy installation of all framed and frameless photovoltaic modules. The setup allows  $\pm 45^\circ$  of tilt and  $\pm 6^\circ$  of side to side flexibility. The Vertical Post system allows up to 12 inches of vertical adjustability in the field with no cutting or welding. Systems are scalable and repeatable.

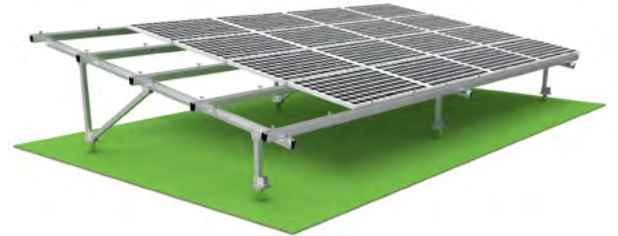

## Module Orientation

Portrait or Landscape

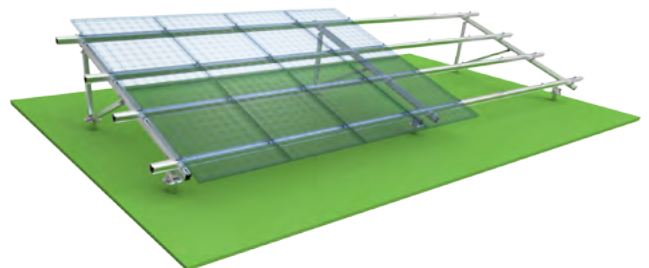
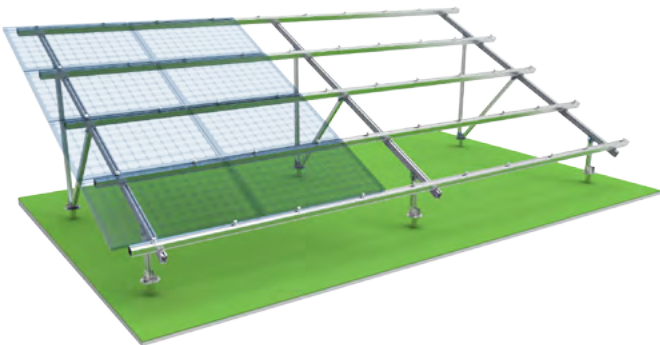



# Maximum Load

System is perfectly optimized towards the location specific wind, snow, and seismic load requirements.



Doubly reinforced beam design



Singly reinforced beam design



V Shaped support

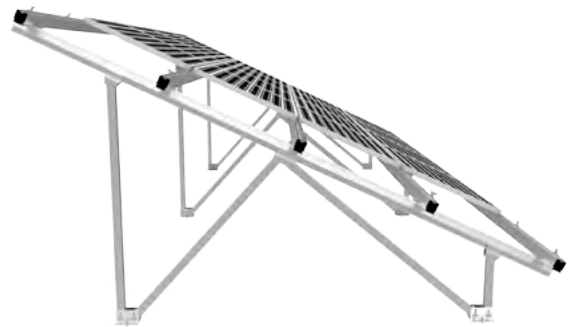

W Shaped support



Hopergy's Solar carports are a simple yet powerful form of building-integrated photovoltaics (BIPV) that cleverly takes advantage of a carport's intended function as a sunshade by installing solar panels or amorphous solar film on top to capture and utilise the sun's rays. The concept speaks for itself, and without much thought it is easy to look around and find opportunities throughout the world to convert driveways, car parks, car ports, gazebos, and even bus stop covers into power producers.

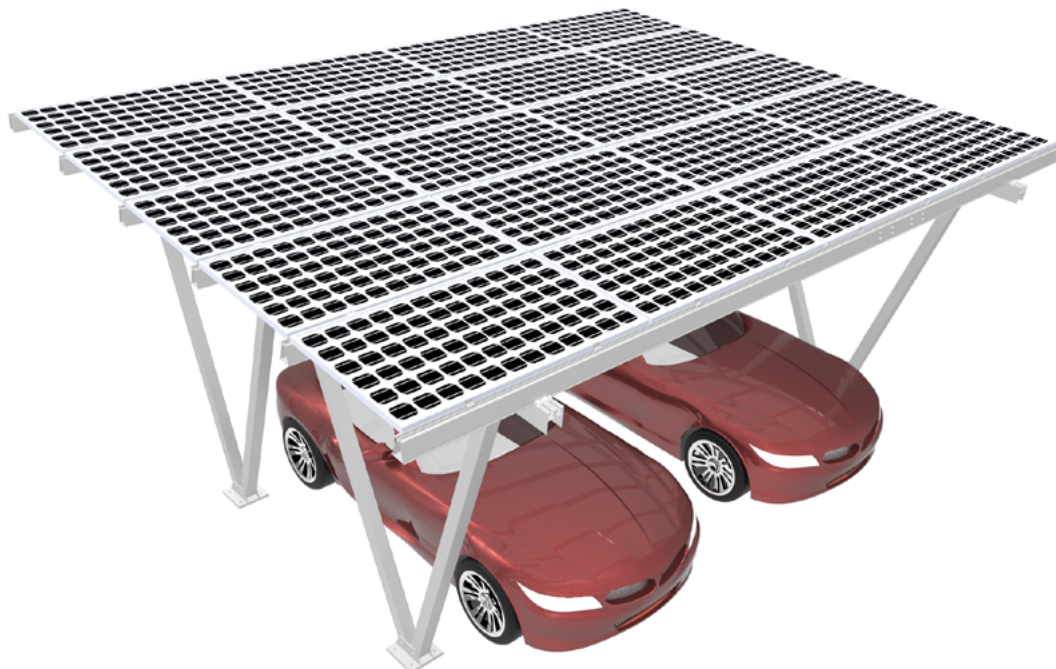



## Feature

- Quick and uncomplicated mounting
- Optimum area utilisation
- Suitable for all types of modules
- For any desired alignment or module inclination
- Competent project planning advice and creation of drawings
- Complete structural analysis for each project
- Construction completely made of aluminium
- Durable and corrosion-free
- Customised foundation options
- Complete documentation in the form of system drawings
- Individual customer design, on request in different colours





Hopergy's extruded aluminium rails are unique in design and are patented internationally. Manufacturing processes are certified in accordance with ISO 9001. The products themselves undergo stringent testing for quality control and compliance with local regulations and standards. As a result, Hopergy's rails have earned reputation for their production quality, durability, performance, service life, economy and ease of assembly and installation.



	Product	Description	Material
1	HOP-SSR*	Select Rail	AL6005-T5
2	HOP-SLR*	Select Lite Rail	AL6005-T5
3	HOP-LXR*	LEX Rail	AL6005-T5

\*various versions available





1 HOP-SNK



2 HOP-SLN

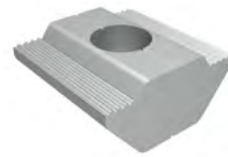

3 HOP-SSK



4 HOP-SRC



	Product	Description	Material
1	HOP-SNK	Select Fixing Bolt and Nut	AL6005-T5
2	HOP-SLN	Select Fixing Nut	AL6005-T5
3	HOP-SSK	Select Rail Joiner	AL6005-T5
4	HOP-SRC	Select Rail Clamp	AL6005-T5



Hopergy's module clamps are preassembled and can be easily mounted with every Hopergy rail. For mounting of modules with module frame depths of 30 - 50 mm. All insert nuts are self-locking and can be moved by applying light pressure to the stainless steel screw in the rail. On request available in black (anodized)

1 HOP-ECS



2 HOP-ICS



3 HOP-TEC



4 HOP-TIC





5 HOP-UEC



6 HOP-UIC



7 HOP-LEC

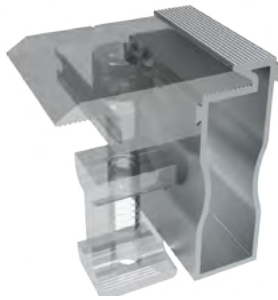

8 HOP-LIC



	Product	Description	Material
1	HOP-ECS	Standard End Clamp	AL6005-T5
2	HOP-ICS	Standard Inner Clamp	AL6005-T5
3	HOP-TEC	Thin Film End Clamp	AL6005-T5
4	HIOP-TIC	Thin Film Inner Clamp	AL6005-T5
5	HOP-UEC	Universal End Clamp	AL6005-T5
6	HOP-UIC	Universal Inner Clamp	AL6005-T5
7	HOP-LEC	LEX End Clamp	AL6005-T5
8	HOP-LIC	LEX Inner Clamp	AL6005-T5



Hopergy's Ground Screw provides utmost stability, efficiency and sustainability to many applications, such as photovoltaic solar farm construction. Compared to concrete footings, which can take hours to set, Powerscrew can be installed in just minutes and built on immediately.

Material: Hot-dip Galvanized Steel Q235





1 HOP-ELG



2 HOP-EPL



3 HOP-LXE



4 HOP-PCC



5 HOP-LXC\*



\*various versions available

	Product	Description	Material
1	HOP-ELG	Earthing Lug	AL6005-T5
2	HOP-EPL	Standard Earthing Plate	AL6005-T5
3	HOP-LXE	LEX Cable Clip	AL6005-T5
4	HOP-PCC	Panel Cable Clip	AL6005-T5
5	HOP-LXC*	LEX Cable Cover	AL6005-T5



## HEADQUARTER

**Address :** 630 Tonghong Road,  
Tongan District, Xiamen 361100  
CHINA

**Phone :** +86-592-5689685

**Fax :** +86-592-5638096

**Mail :** info@hopergy.com



## AUSTRALIA

**Address :** Unit 3/247 Ferntree  
Gully Road, Mount Waverley  
VIC 3149 Australia

**Phone :** +61 1300 655 554

**Mail :** sales.au@hopergy.com



## JAPAN

**Address :** 2-2-11 Yoshin Bla,3F  
Yariyamachi Chuo-Ku

Osaka-Shi Osaka Japan

**Phone :** +81 06-6809-4426

**Mail :** sales.jp@hopergy.com



## NEW ZEALAND

**Address :** 1 Heremai St  
Henderson Auckland, 0612

**Phone :** +64 09 390 2280

**Mail :** sales.nz@hopergy.com



## PHILIPPINES

**Address :** 10-1 Net One Center  
26th Street corner 3rd Ave,  
BGC, Taguig

**Phone :** +63 09 36967 0701

**Mail :** sales.ph@hopergy.com



## THAILAND

**Address :** 1/19 Bangnatani  
Building 9th FL., Soi Bangna-  
Trad 34, Bangna-Trad KM.3 Rd.,  
Bangna, Bangkok Thailand 10260

**Phone :** +66 02 3988053

**Mail :** sales.th@hopergy.com



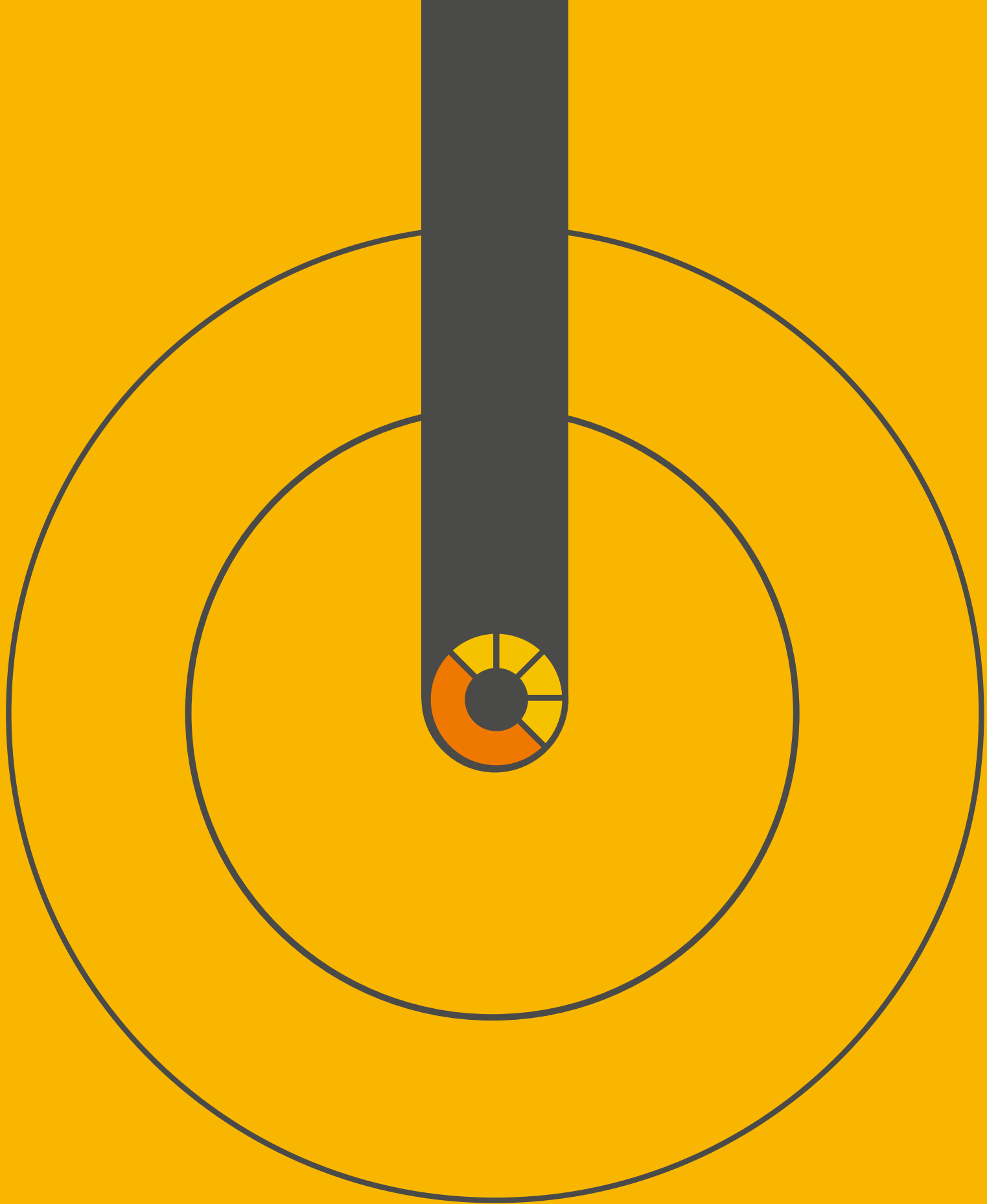

**Address :** 630 Tonghong Road, Tongan District,  
Xiamen 361100 CHINA

**Phone :** +86-592-5689685 **Fax :** +86-592-5638096

**Mail :** [info@hopergy.com](mailto:info@hopergy.com)